

Paper roll clamp 360°

PRK 35
ISO II/III

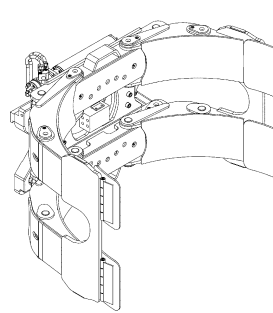

long arm unsplit

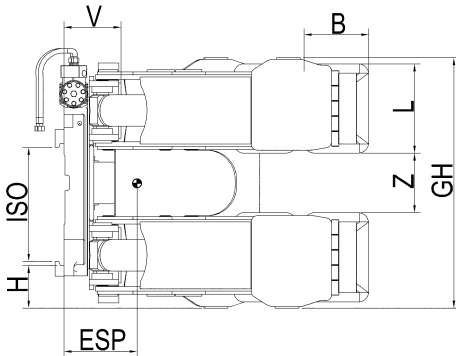
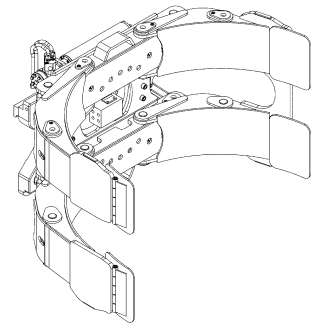

long arm split

type	capacity kg LC mm	min. carriage mm	ISO	roll diameter min - max mm	short arm	GH mm	contact plates B x L mm	Z mm	H mm	V LLC mm	COG/ESP hor. mm	COG/ESP vert. mm	weight kg
PRK 35 - Long arm unsplit													
PRK 35 B - 13	2500/650	950	II/III	250 - 1300	powered	840	220x300	200	143	197	235	284	735
PRK 35 S - 13	2500/650			500 - 1300	fixed						235		730
PRK 35 B - 14	2200/725			250 - 1450	powered						248		760
PRK 35 S - 14	2200/725			500 - 1450	fixed						248		755
PRK 35 B - 15	2100/760			250 - 1520	powered						260		790
PRK 35 S - 15	2100/760			500 - 1520	fixed						260		785
PRK 35 B - 16	2000/800			250 - 1600	powered						275		815
PRK 35 S - 16	2000/800			600 - 1600	fixed						275		810
PRK 35 B - 18	1700/915			350 - 1830	powered						301		850
PRK 35 S - 18	1700/915			630 - 1830	fixed						301		845
PRK 35 - Long arm split													
PRK 35 TB - 13	2500/650	950	II/III	250 - 1300	powered	840	220x300	200	143	197	230	284	725
PRK 35 TS - 13	2500/650			500 - 1300	fixed						230		720
PRK 35 TB - 14	2200/725			250 - 1450	powered						243		750
PRK 35 TS - 14	2200/725			500 - 1450	fixed						243		745
PRK 35 TB - 15	2100/760			250 - 1520	powered						255		780
PRK 35 TS - 15	2100/760			500 - 1520	fixed						255		775
PRK 35 TB - 16	2000/800			250 - 1600	powered						270		805
PRK 35 TS - 16	2000/800			600 - 1600	fixed						270		800
PRK 35 TB - 18	1700/915			350 - 1830	powered						296		840
PRK 35 TS - 18	1700/915			630 - 1830	fixed						296		835

- 2 hydraulic functions required
- includes hoses and couplings
- optional surfaces see page 72
- other surfaces upon request
- centre cover upon request

- 160 bar pressure at entry required, less pressure results in less clamping force
- powered short arm sequential movement as standard, positioning at 45°, choose on order (no add-on price)
- 0° arm design upon request

- one piece contact plate per arm upon request
- load extender upon request
- quick release hooks ISO II/III upon request
- force options see page 249



image shows unit complete with optional centre cover